

Performance characteristics:

- RF/LO band: 3GHz ~ 10GHz
- IF band: DC ~ 4GHz
- Frequency conversion loss: 7dB
- RF-IF isolation: 18dB
- LO-IF isolation: 35dB
- LO-RF isolation: 45dB
- Local oscillator power: 17dBm
- Package size: 3*3 QFN 12L

Functional block diagram

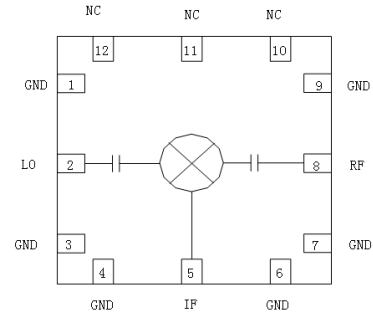

Product Description:

CW-MX787SP3B is a GaAs MMIC passive double balanced mixer chip, with RF/LO frequency covering 3 ~ 10GHz and IF frequency covering DC ~ 4GHz respectively, conversion loss less than 8.5 dB, RF-IF isolation greater than 16dB, LO-IF isolation greater than 32dB, LO-RF isolation greater than 42dB, and typical LO input power of 17dBm.

Electrical parameters: (TA=25 °C, IF=0. 1GHz, LO=17dBm)

Indicators	Minimum value	Typical value	Maximum value	Unit
Radio frequency		3 ~ 10		GHz
Local oscillator frequency		3 ~ 10		GHz
Intermediate frequency		DC ~ 4		GHz
Frequency conversion loss	6	7	8.5	dB
RF-IF isolation	16	18	25	dB
LO-IF isolation	32	35	37	dB
LO-RF isolation	42	45	55	dB
P1dB (input)	9	12	15	dBm

Use limit parameters: (Exceeding any of the above maximum limits may cause permanent damage.)

RF/IF power	26dBm
Local oscillator power	26dBm
Storage temperature	-65 °C ~ 150 °C
Operating temperature	-55 °C ~ 125 °C

Typical curve:

Frequency conversion loss @
LO=17dBm, IF frequency 0.1 GHz

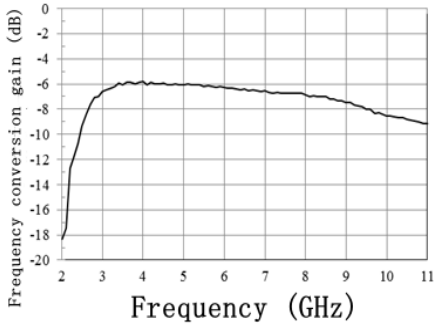

Isolation @ LO=17dBm, IF 0.1 GHz

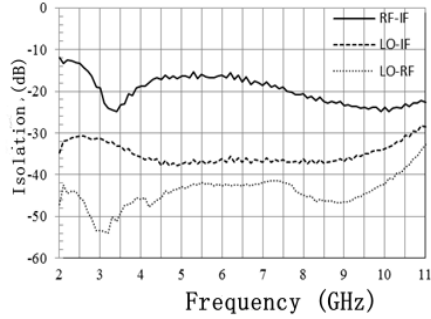

Frequency conversion loss
@ IF frequency 0.1 GHz

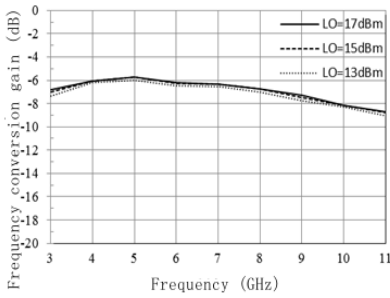

IF bandwidth @ LO=10GHz,
LO=17dBm

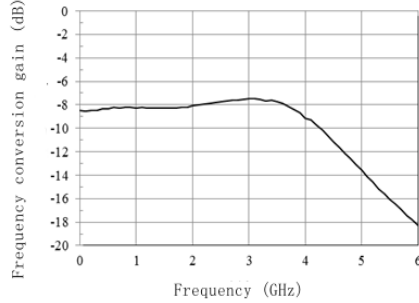

RF return loss

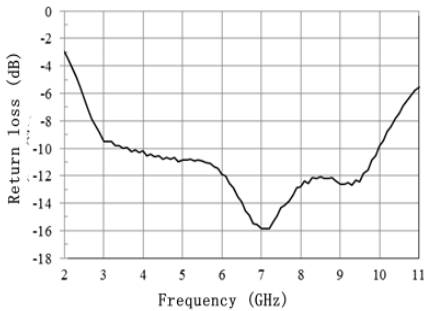

IF return loss

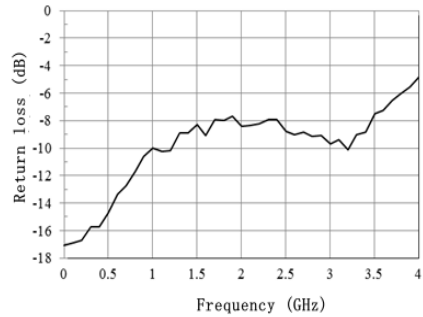

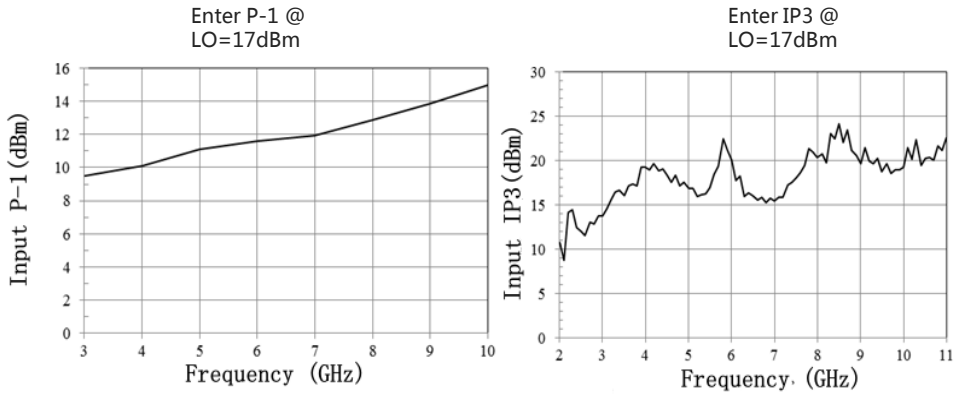

Absolute maximum rating

RF/IF input power	28dBm
LO input power	28dBm
Storage temperature	-65 °C ~ + 150 °C
Operating temperature	-40 °C ~ + 85 °C
ESD_HBM	Class 1A

Typical application

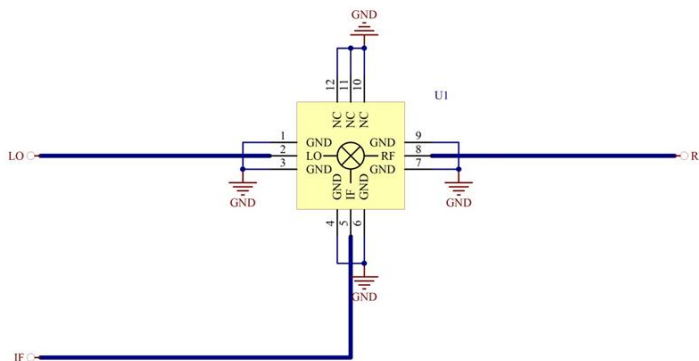

Package outline dimensions

05

Mixer

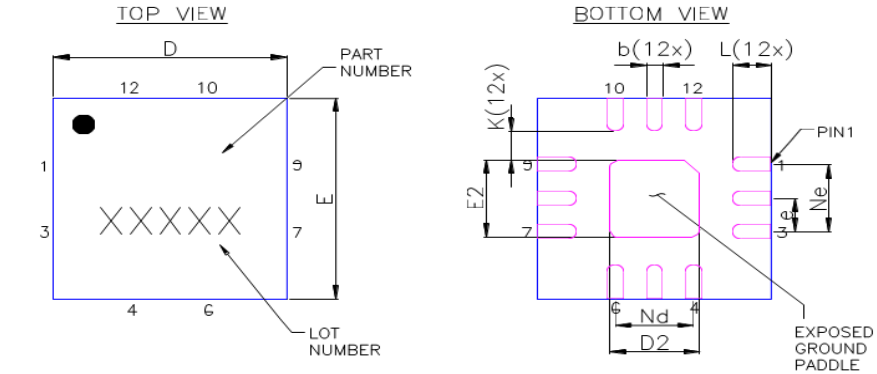

- Description: 1. Unit: mm
 2. Lead frame material: copper alloy
 3. Package surface warpage: $\leq 0.05\text{mm}$
 4. Please connect all ground pins to PCB RF ground

Symbol	MIN	NOM	MAX
A	0.70	0.75	0.80
A1	0.00	0.02	0.05
A2	0.20Ref		
b	0.17	0.22	0.27
D	2.90	3.00	3.10
D2	1.05	1.15	1.25
e	0.50BSC		
Ne	1.00BSC		
Nd	1.00BSC		
E	2.90	3.00	3.10
E2	1.05	1.15	1.25
K	0.20	---	---
L	0.40	0.50	0.60
aaa	0.08		

Absolute maximum rating

Pin number	Functional symbol	Functional description
1;3;4;6;7;9	GND	RF ground, the exposed paddle at the bottom of the package is also RF & DC RF ground.
2	LO	Local Oscillator Port, AC Coupled Outside Matched 50 Ω , With Isolation Capacitor
5	IF	IF Port, DC Coupled Outside Matched 50 Ω No Isolation Capacitors
8	RF	RF port, AC coupled outer matching 50 Ω , with isolation capacitors.
10-12	NC	No internal connections

IF port definition

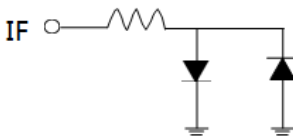

LO port definition



RF Port Definition

